

Fitting Instructions for Arcisan Mirror

Thanks for purchasing an Arcisan mirror. For safety reasons, we kindly ask you to read this installation and user guide carefully before you install and use the product.

FITTING INSTRUCTIONS - See also below

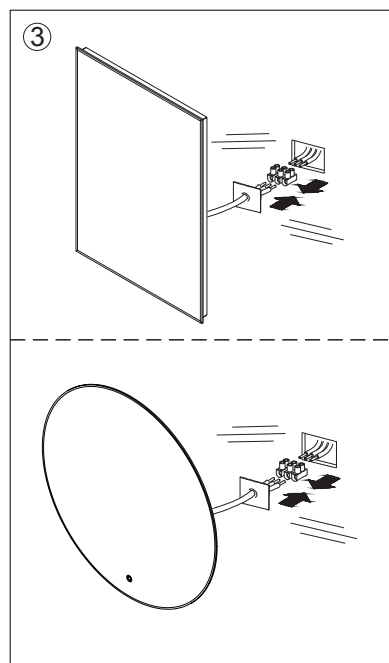
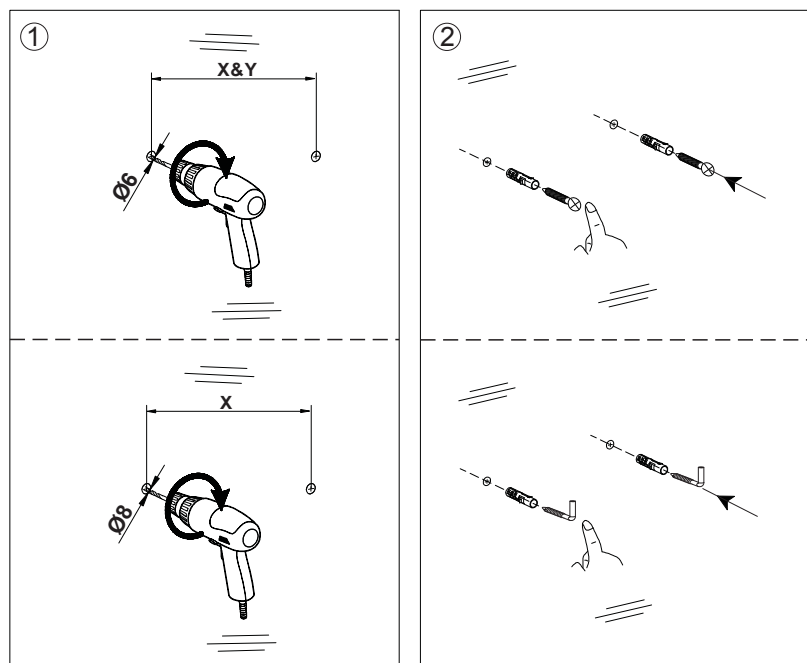

DIMENSIONS

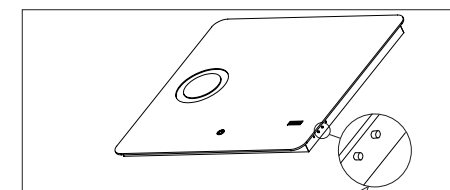
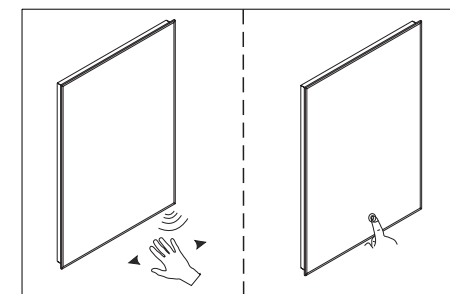
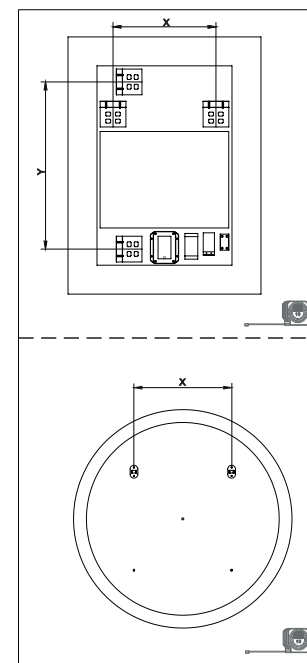

1 - Long press on left key, clock enters in setting up mode. First number starts flashing. Press the right key to choose numbers, 1 or 2.
2 - In setting mode, short press on left key, choose number position to adjust, then press right key to choose the number.

FITTING INSTRUCTIONS

1. Handle with care. When unpacked, never place mirror upright on a hard surface e.g. Tile Floor. Always lay on soft surface.
2. Drill 2 holes on wall surface as per diagram 1 to desired height. 64" from floor to centre of mirror is advised but may be adjusted as required, Use spirit level to ensure holes are level. If drilling through tiles, use a ceramic drill bit.
3. Inset rawl plugs into holes and screws into holes.
4. Attach wire from back of mirror to mains wire in accordance with current IEE regulations. A second person will be needed to hold the mirror in place.
5. Hang the mirror onto the screws via holes in the frame.
6. Some mirrors may be hung portrait or landscape.
7. A distance of 80 mm is necessary between the sensor switch and any other object in any direction
8. Enjoy!

GENERAL INFORMATION

- This mirror is suitable for Zone 2 or higher and not Zone 0 or 1 (see diagram)
- We advise that you consult a qualified electrician for the installation.
- Switch off electrical supply at mains before fitting.
- Ensure wall surface is of suitable strength and construction.
- Beware of hidden cables or pipes.
- For plasterboard walls, specialist fixings should be purchased from DIY or hardware stores.
- The mirror is heavy so you may need assistance.
- Turn lights on/off using infra red sensor -leave off when not in use.
- Heat pat turns on with light switch and takes 2/3 minutes to heat up.

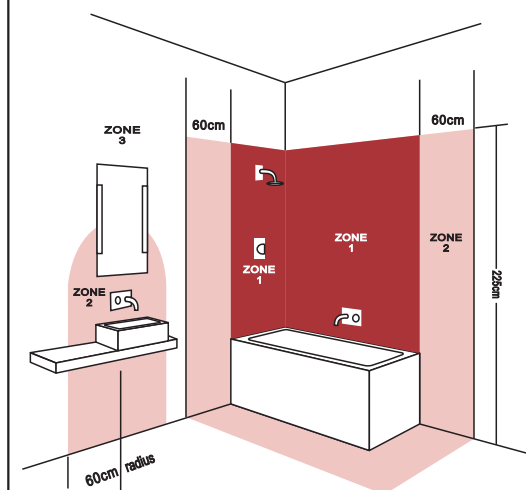

Fitting Instructions for Arcisan Mirror

Instructions apply to all the following mirrors:

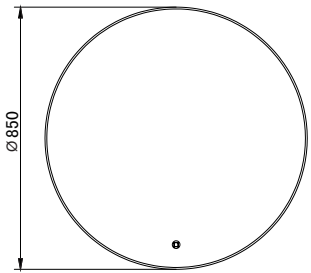

PZ 06110
Ø850

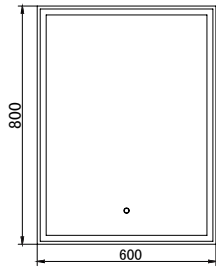

KU 06110
600x800

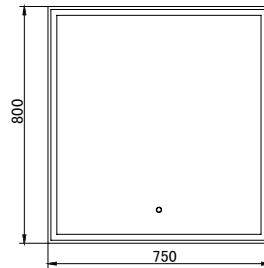

KU 06112
750x800

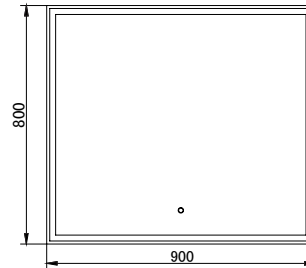

KU 06114
900x800

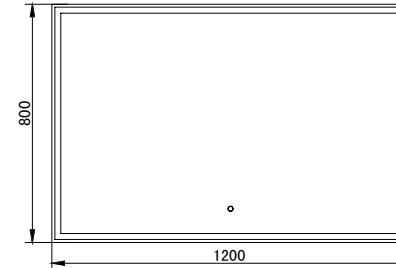

KU 06116
1200x800

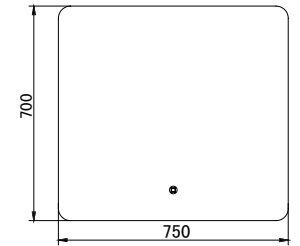

EN 06110
750x700

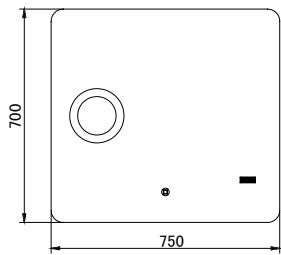

EN 06210
750x700

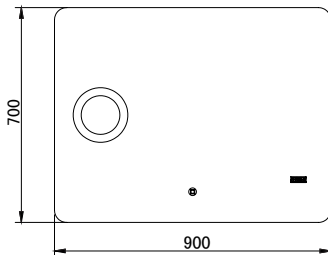

EN 06211
900x700

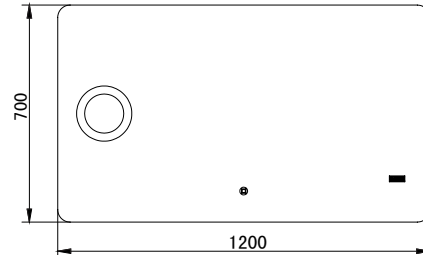

EN 06214
1200x700

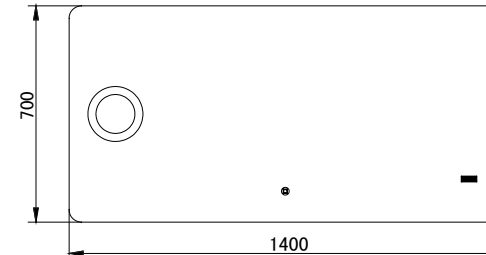

EN 06216
1400x700

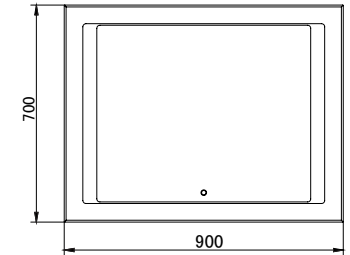

AR 06112
900x700

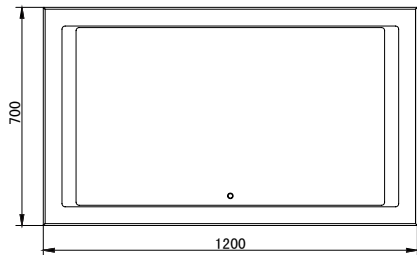

AR 06114
1200x700

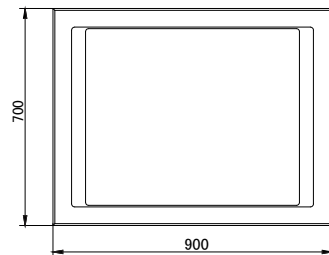

LY 06112
900x700

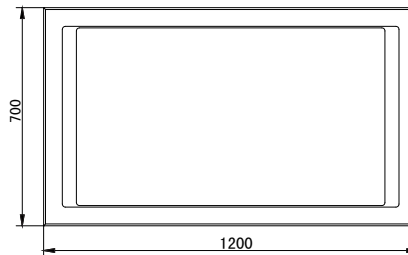

CY 06114
1200x700

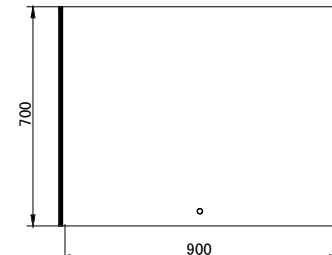

KB 06110
900x700

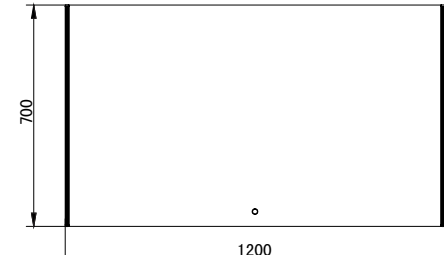

KB 06112
1200x700