

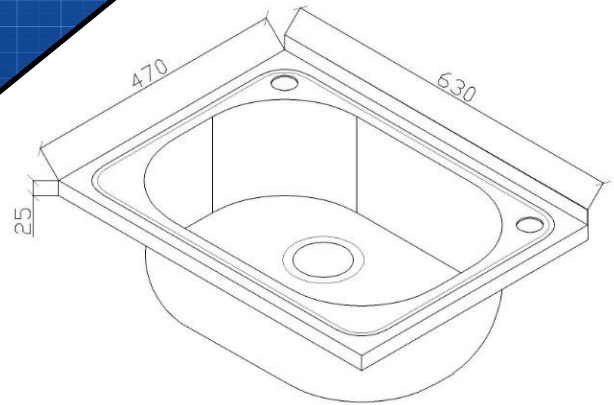

LUS60P

45 Litre

Laundry Unit



FEATURES & BENEFITS

- Durable white high gloss finish to all sides
- Designed for easy installation
- Fully assembled (no assembly required)
- Soft closing doors
- Stylish chrome handles

SIZE

- 625mm W x 465mm D x 895mm H

COLOUR

- Gloss White

MANUFACTURING MATERIALS

- PVC Board
- 304 Stainless Steel Bowl
- Durable 2 pack painted surface

GUARANTEE

- All Alpine cabinets come with a genuine 5 Year Warranty which covers materials used and workmanship at the time of manufacture.

Dimensions and set-outs are correct at the time of publication, however the manufacturer/ distributor takes no responsibility for printing errors.

The manufacturer/distributor reserves the right to vary specifications or delete models from their range without prior notification.

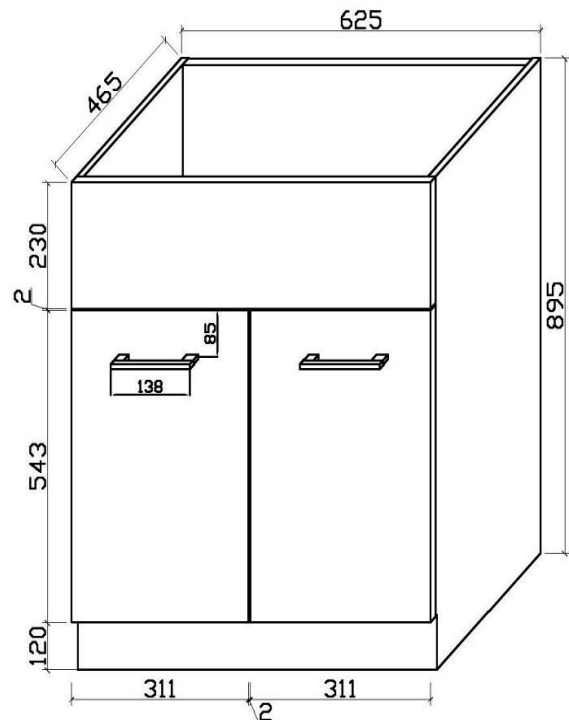

www.alpinekb.com.au