

PLATI 016

CERAMIC BASIN



Inset above counter basin, rectangular

This contemporary inset basin has generous capacity with a low above counter profile and most of the basin sitting below the benchtop. The wide rim enables this inset basin to be used with a variety of benchtop materials.

ORDER CODE	191444	Plati 016, 1 taphole	Old code: SBC-016
	191445	Plati 016, no taphole	Old code: SBC-016-0T
TAPHOLE	0 or 1 taphole.		
WASTE	Suits standard 32 mm waste with overflow (not supplied).		
CAPACITY	6 litres.		
OVERFLOW	Standard with overflow.		
MATERIAL	White vitreous china.		
COLOUR	White.		
FIXING	Always use the actual basin to verify cutout. Use silicone sealant. Do not use epoxy type adhesives.		

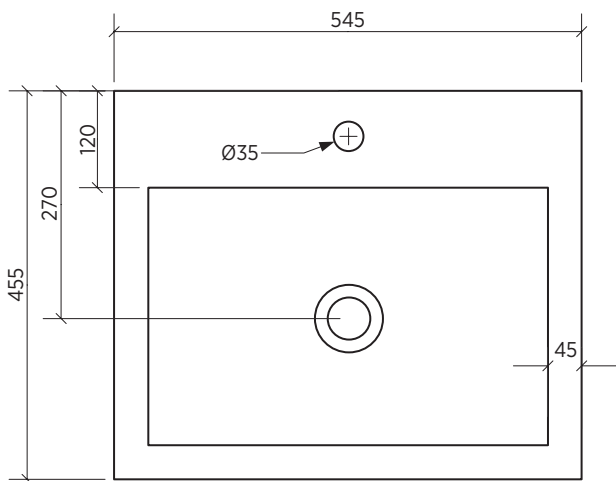

BENCH CUTOUT

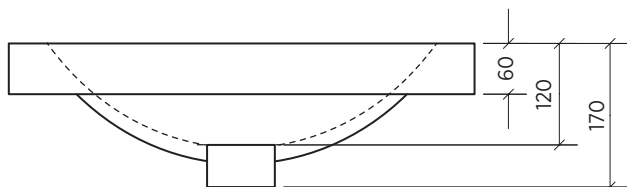
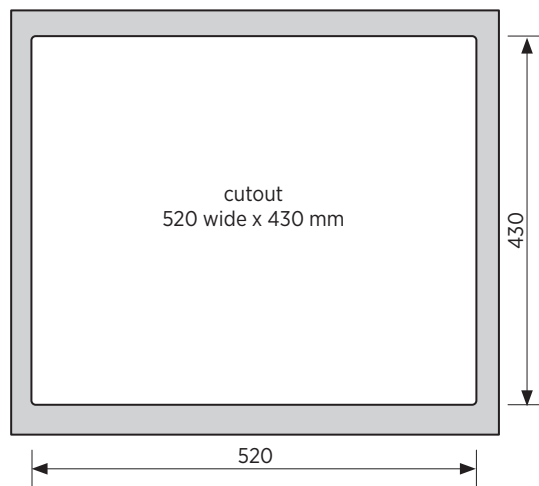

 Basin has integrated overflow

SEIMA

bathroom | kitchen | laundry

seima.com.au

Please note

- All measurements are in millimetres.
- Dimensions are nominal and subject to normal ceramic manufacturing variations of ±5mm.
- Fixing: Use silicone sealant. DO NOT USE EPOXY TYPE ADHESIVES.
- Always use the actual basin to verify cutout.
- Specifications may vary without notice as part of our continuous improvement practices.
- Clean with a damp cloth. Do not use abrasive cleaners, liquids or pastes.

plati-016-ds | v 4.0