

# Nu-Petite

## NP60U

Double Bowl Undermount Sink



All dimensions in mm

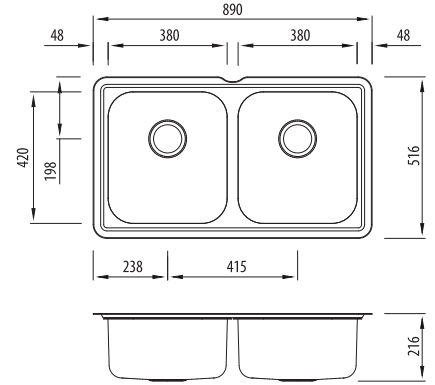

### Specifications /

<b>Sink size</b>	890W x 516H mm
<b>Bowl size</b>	Main Bowl 380W x 420H x 200D / 30L Main Bowl 380W x 420H x 200D / 30L
<b>Construction</b>	2 piece, bowls and rim seam welded
<b>Material</b>	304 grade, 18/10 polished stainless steel (0.8 mm thick)
<b>Installation</b>	Undermount
<b>Fixings</b>	Available on request
<b>Min cabinet size</b>	900 x 720 mm
<b>Tap holes</b>	N/A
<b>Waste fittings</b>	2 x 90 mm basket wastes included
<b>Overflow</b>	Not available
<b>Carton size</b>	1043 x 607 x 292 mm
<b>Weight</b>	7 kg
<b>Warranty</b>	Lifetime manufacturer's warranty (refer to <a href="http://oliveri.com.au">oliveri.com.au</a> )
<b>Maintenance and care instructions</b>	All surfaces should be cleaned with mild liquid detergent or soap and water. To maintain the shine on your Oliveri stainless steel sink, we recommended the use of any of the easy to obtain, non-abrasive stainless steel cleaners or metal polishes.

### Included accessories /

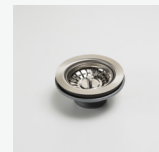

**AC14**  
Basket Waste



**AC14**  
Basket Waste



**AC65**  
Bamboo Board



**AC6220**  
Colander



**AC6320**  
Utility Tray